

# CONCORD

4340z

4.0 MEGAPIXELS

## *User's Guide*



[www.concord-camera.com](http://www.concord-camera.com)

# Table of contents

## 1 Getting Started

Package Contents.....	1
System Requirements.....	2
Windows.....	2
Macintosh.....	2
Safety Information.....	3
FCC Compliance and Advisory.....	4
Camera Components.....	5
Front.....	5
Rear.....	5
Top.....	5
Side.....	6
Using the Included Accessories.....	6
Attaching the Wrist Strap.....	6
Using the Soft Case.....	6
Operating the Multi-controller.....	7

## 2 Preparing the Camera

Installing the Batteries.....	8
Battery Status Indications.....	8
Installing an SD Card.....	9
To remove the SD card.....	9
Formatting Internal Memory Or Card Memory.....	9
Turning the Power On / Off.....	10
Using the Camera Mode Button.....	11
Setting the Date and Time.....	11
Date Stamp.....	12
Setting the Language.....	12
Selecting Menus and Settings.....	13

## 3 Basic Functions

Setting the LCD Display Mode.....	15
Shooting Mode.....	15
Playback Mode.....	15
Information Displayed on the LCD	
Monitor.....	16
Shooting Mode.....	16
Playback Mode.....	16

Using the Zoom Feature.....	17
-----------------------------	----

## 4 Taking Pictures

Basic Still Image Shooting.....	18
Reviewing the Image after Shooting.....	19
Setting the Image Quality and Resolution.....	19
Using the Flash.....	20
Tips on Red-Eye Reduction feature.....	20
Setting the Metering Mode.....	21
Macro Mode.....	21
Setting the Self-Timer and Continuous Shooting.....	22
Shooting in Long Shutter Mode.....	23
Adjusting the Exposure ---EV adjustment.....	23
Adjusting Color Tones ---Setting the White Balance.....	24
Using the Self-Portrait Mirror.....	24
Video Mode.....	25

## 5 Reviewing Photo & Video Clips

Reviewing Files.....	26
Magnifying Images.....	26
Viewing the Files in Thumbnail Mode.....	27
Erasing Files From Memory.....	27
Erasing Images Individually.....	27
Erasing files by using the Review Menu.....	28
Protecting Photos and Video Clips.....	28
Playing a Slide Show (Auto Play).....	29

<b>Copying Files from Internal Memory to an SD Card .....</b>	<b>29</b>
<b>Setting USB Mode.....</b>	<b>29</b>

## **6 File Names & Printing**

<b>About File and Folder Numbers .....</b>	<b>30</b>
Folder File Capacity .....	30
<b>File Number Reset .....</b>	<b>31</b>
<b>DPOF Print Settings .....</b>	<b>32</b>
<b>Printing still images with a PictBridge printer.....</b>	<b>33</b>
<b>Printing images .....</b>	<b>33</b>
<b>Setting Print Size.....</b>	<b>34</b>
<b>PictBridge Custom Menu.....</b>	<b>35</b>

## **7 Software Installation Guide**

<b>Using the Installer Splash Screen.....</b>	<b>36</b>
<b>Identifying Your Operating System.....</b>	<b>37</b>
<b>Installing the Driver And Directx 9 – Windows98/98se .....</b>	<b>38</b>
<b>Installing Directx 9–Windows 2000 .....</b>	<b>40</b>
<b>Installing Arcsoft Photoimpression – Allwindowsusers.....</b>	<b>41</b>
<b>Installing Adobe Acrobat Reader 5- All Windows Users (Optional).....</b>	<b>43</b>

## **8 Making Connections**

<b>Downloading Images to a Computer .....</b>	<b>46</b>
Downloading the Files by Using an SD Card Reader .....	46
Connecting the Camera to a	

Computer with a USB Cable .....	47
<b>Understanding Camera Memory and Storage.....</b>	<b>48</b>
<b>Using arcsoft photoimpression(windows only).....</b>	<b>49</b>

## **9 Appendix**

<b>Troubleshooting .....</b>	<b>51</b>
<b>Specifications .....</b>	<b>52</b>
<b>Getting Help .....</b>	<b>53</b>

# 1 Getting Started

## Package Contents

Please contact your dealer immediately if any of the items below are missing or damaged.

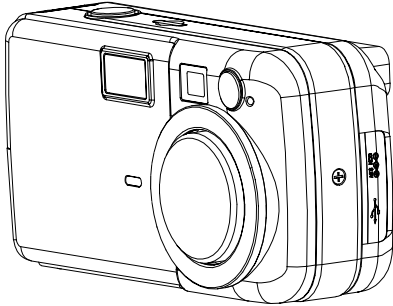

Camera

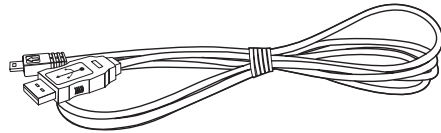

USB Cable

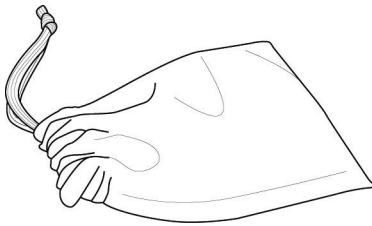

Soft Case

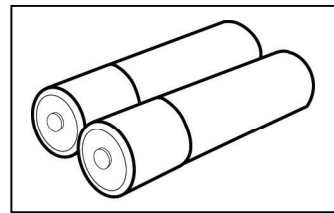

2 AA Batteries

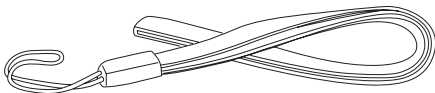

Strap

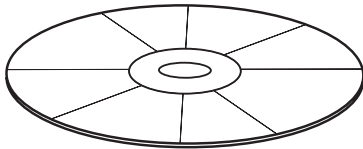

Software Installation  
CD-ROM  
(including multilingual  
user's guide)

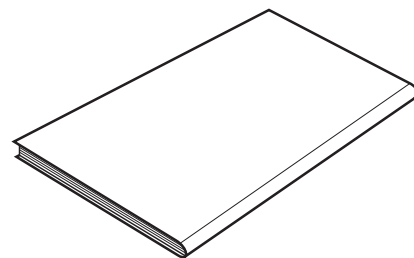

Quick Start Guide

# System Requirements

## Windows:

- PC with processor better than MMX Pentium 300 MHz
- Windows XP/2000/ME/98
- Minimum 128 MB RAM
- USB port
- CD-ROM drive
- 1024 x 768 monitor, 24-bit color (true color)

## Macintosh:

- Power Mac G3 or later
- Mac OS 9.0, 9.1, 9.2 and OS X
- Minimum 64 MB RAM
- USB port
- CD-ROM drive
- 640 x 480 monitor with thousands of color (millions of color recommended)

Specifications are subject to change without prior notice.

## Safety Information

- Before using the camera, please ensure that you read and understand the safety precautions described below. Always ensure that the camera is operated correctly.
- Do not aim the camera directly into the sun or other intense light sources which could damage your eyesight.
- Do not try to open the case of the camera or attempt to modify this camera in any way. High-voltage internal components create the risk of electric shock when exposed. Maintenance and repairs should be carried out only by authorized service providers.
- Do not fire the flash too close to the eyes of animals or people, especially for young children. Eye damage may result. In particular, remain at least one meter away from infants when using flash.
- Keep the camera away from water and other liquids. Do not use the camera with wet hands. Never use the camera in the rain or snow. Moisture creates the danger of fire and electric shock.
- Keep the camera and its accessories out of the reach of children and animals to prevent accidents or damage to the camera.
- If you notice smoke or a strange odor coming from the camera, turn the power off immediately. Take the camera to the nearest authorized service center for repair. Never attempt to repair the camera on your own.
- Use only the recommended power accessories. Use of power sources not expressly recommended for this equipment may lead to overheating, distortion of the equipment, fire, electrical shock or other hazards.

## FCC Compliance and Advisory

This device complies with Part 15 of the FCC Rules. Operation is subject to the following two conditions: 1.) This device may not cause harmful interference, and 2.) This device must accept any interference received, including interference that may cause unsatisfactory operation.

This equipment has been tested and found to comply with the limits for a Class B peripheral, pursuant to Part 15 of the FCC Rules. These limits are designed to provide reasonable protection against harmful interference in a residential installation. This equipment generates, uses, and can radiate radio frequency energy and, if not installed and used in accordance with the instructions, may cause harmful interference to radio communication. However, there is no guarantee that interference will not occur in a particular installation. If this equipment does cause harmful interference to radio or television reception, which can be determined by turning the equipment off and on, the user is encouraged to try to correct the interference by one or more of the following measures.

- Reorient or relocate the receiving antenna.
- Increase the separation between the equipment and receiver.
- Connect the equipment to an outlet on a circuit different from that to which the receiver is connected.
- Consult the dealer or an experienced radio/TV technician for help.

Any changes or modifications not expressly approved by the party responsible for compliance could void the user's authority to operate the equipment. When shielded interface cables have been provided with the product or when specified additional components or accessories have elsewhere been designated to be used with the installation of the product, they must be used in order to ensure compliance with FCC regulations.

# Camera Components

## Front

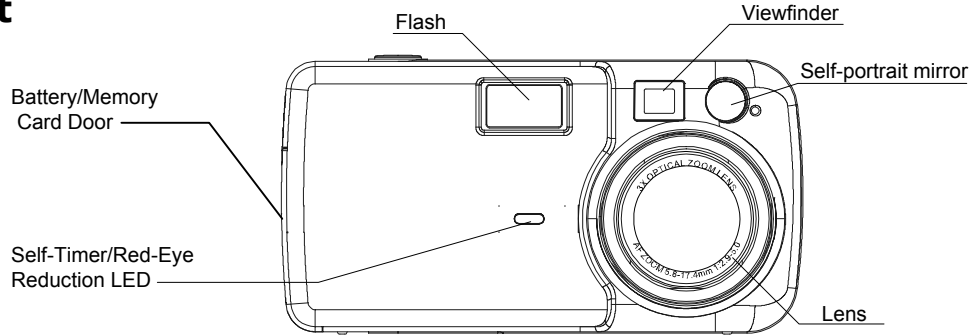

## Rear

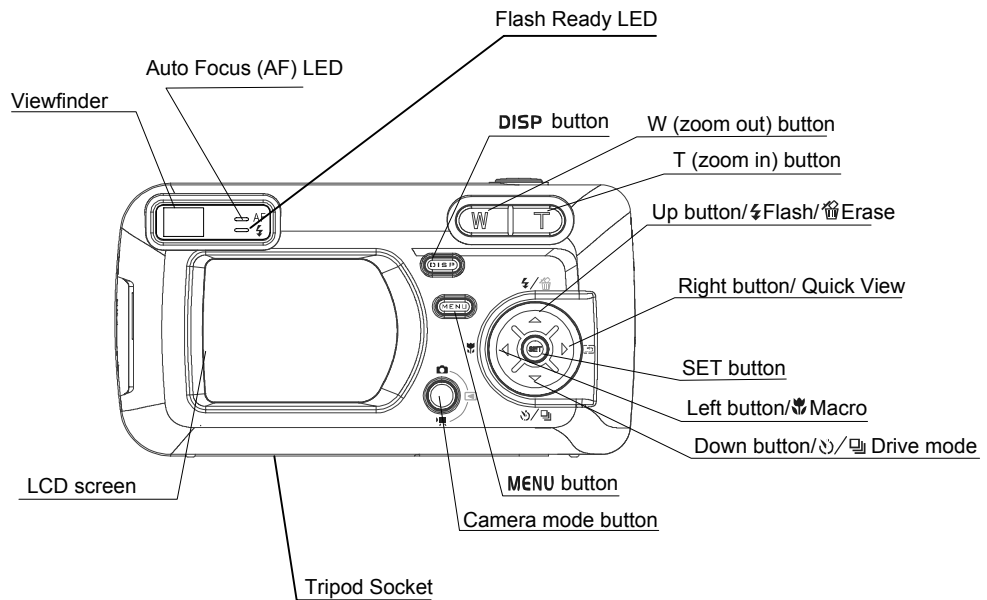

## Top

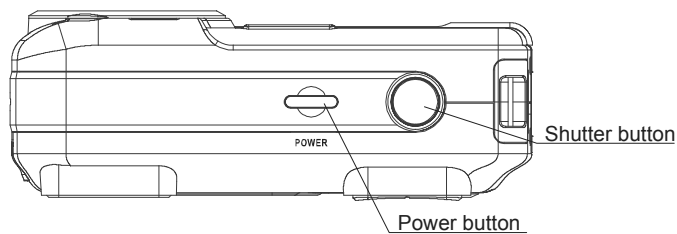



## Side

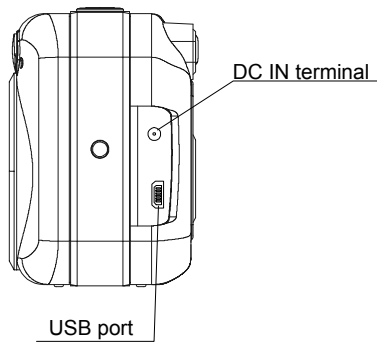

## Using the Included Accessories

### Attaching the Wrist Strap

Attach the wrist strap as illustrated.



*Don't swing the camera when carrying it by the wrist strap.*

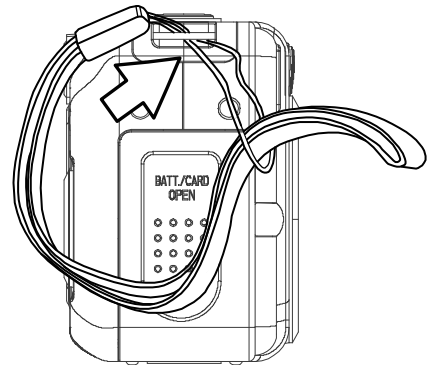

### Using the Soft Case

Store the camera in the soft case when it is not in use.

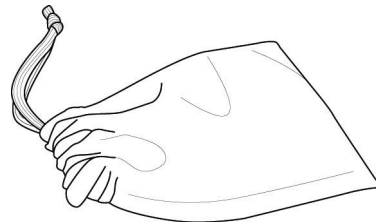

## Operating the Multi-controller

The multi-controller is used to set shooting mode, to move cursor when the camera Menu is shown, and to confirm the selection.

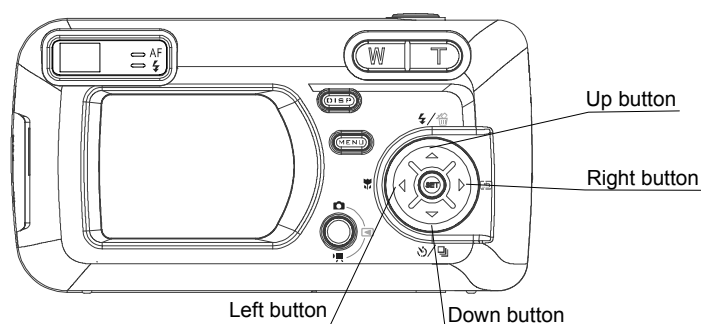

### Up Button (▲)

- To set the Flash mode in Shooting Mode.
- To delete files in Review Mode.
- To move the cursor up when MENU screen is shown.

### Right Button (▶)

- To enter Quick View mode.
- To move the cursor to right when MENU screen is shown
- To enter submenu.

### Down Button (▼)

- To set Continuous Shot in Shooting Mode.
- To set Self-Timer in Shooting Mode and Video Mode.
- To move the cursor down when MENU screen is shown.

### Left Arrow (◀)

- To set Macro shooting in Shooting Mode and Video Mode.
- To move the cursor left when MENU screen is shown.

### SET Button

- To enter submenu.
- To confirm the setting.

## 2 Preparing the Camera

### Installing the Batteries

Insert two (2) AA-size alkaline batteries (included with the camera)

1. Be sure that the camera power is off.
2. Slide the Battery/Memory Card door in the direction of the arrow, and lift it open.
3. Insert two AA batteries with the positive (+) and negative (-) poles matching the directions indicated inside the battery cover.
4. Close the Battery/Memory Card door.

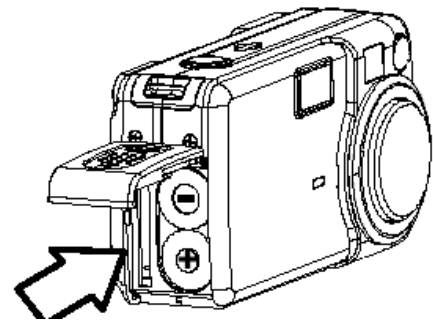
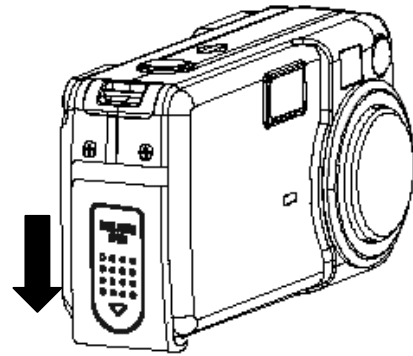

### Battery Status Indications

The battery power level indicator represents the level of power of the batteries. The meaning of each icon is as follows:

Charge Level	High ←————→ Low
Indicator	

When the battery is running out, the message "Replace Battery" will be displayed on the LCD.



*If POWER button is pressed for over 1 second but the camera still does not power on, the batteries may be drained. Replace the batteries with new ones and try again.*

## Installing an SD Card

1. Turn off the camera.
2. Slide the Battery/Memory Card door in the direction of the arrow to open the door.
3. Insert the SD card as shown in the diagram.

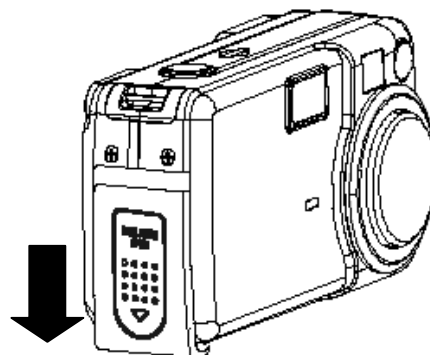

### To remove the SD card

1. Turn off the camera.
2. Slide the Battery/Memory Card door in the direction of the arrow to open the door.
3. Gently press on the edge of the SD card, the card will eject up. Pull the card out and close the Battery/Memory Card door.

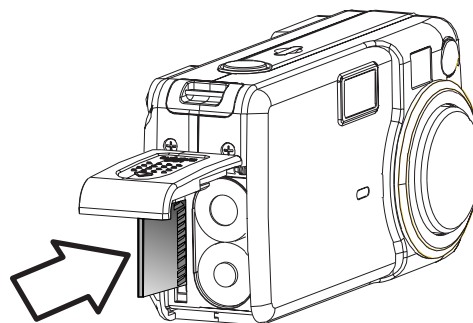

## Formatting Internal Memory Or Card Memory

If you wish to delete all the images and video clips stored in the internal memory or memory card, or when you use a brand new memory card, please follow the steps below to format the internal memory or memory card:

1. Insert the memory card if you want to format the memory card instead of the internal memory.
2. Turn on the camera.
3. Press the **MENU** button.
4. Press the **▶** arrow to select the Setup Menu.
5. press the **▼** or **▲** arrow to select **Format** then press the **SET** button or the **▶** arrow to enter its sub-menu.

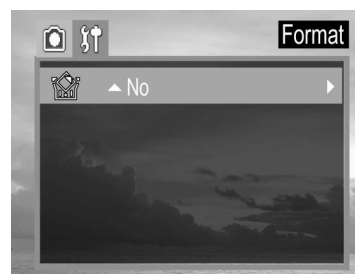

6. Press the ▼ and ▲ arrow to select Yes or No.
7. Press the **SET** button to confirm the selection.



1. *Formatting will erase all the data in the memory, including the protected files. Please check the contents in the memory before formatting it.*
2. *SD cards formatted in another camera, computer or peripheral device may not operate correctly. When that happens, reformat the SD card with this camera.*

## Turning the Power On / Off

Press and hold the **POWER** button for more than 1 second to turn the camera on.

**Note:** You may also press and hold the **Camera Mode** button for more than 1 second to turn the camera on in Review mode and then press the **Camera Mode** button repeatedly to switch to Shooting Mode.

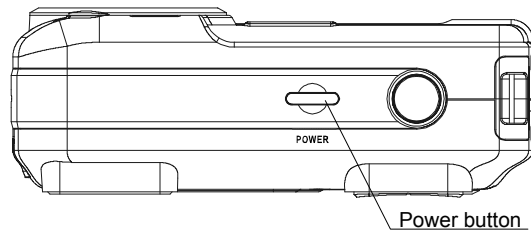

### To turn off the camera



Press the power button to turn off the camera.



*The camera will be powered off automatically after being idle for 3 minutes by default. The Auto-Off timing can be changed in Set-Up menu.*

## Using the Camera Mode Button

Use the **Camera Mode** button to change shooting mode.

	<b>Shooting Mode</b>	<b>For shooting still images</b>
	<b>Review Mode</b>	<b>For viewing the recorded images and video clips.</b>
	<b>Video Mode</b>	<b>For shooting video clips.</b>

The camera mode changes as shown in the following diagram when the **Camera Mode button** is pressed.

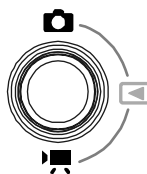

## Setting the Date and Time

1. Turn on the camera.
2. Press the **MENU** button.
3. Press the **▶** arrow to select the Setup Menu.
4. Press the **▼** or **▲** arrow to select **Date & Time** then press the **SET** button or the **▶** arrow to enter its submenu.
5. Press the **◀** and **▶** arrow to select a field to change.
6. Press the **▼** and **▲** arrow to set the values.
7. After the Date, Time and Date/Time format is set, press the **SET** button repeatedly to confirm the settings and then to exit Date/Time submenu.
8. Press the **MENU** button twice to close the menu window.



## Date Stamp

By default the Date Stamp is set at OFF mode. If you want to have Date and Time shown on the pictures, set the Date Stamp to ON mode.

1. Press the **MENU** button.
2. Press the ▼ or ▲ arrow to select **Date Stamp** then press the **SET** button or the ► arrow to enter its submenu.
3. Press the ▼ or ▲ to set **Date Stamp** on/off.
4. Press the **SET** button to confirm the selection.
5. Press the **MENU** button twice to close the menu window.



## Setting the Language

1. Press the **MENU** button.
2. Press the ► arrow to select the Setup Menu.
3. Press the ▼ or ▲ arrow to select **Language** then press the **SET** button or the ► arrow to enter its submenu.
4. Press the ▼ or ▲ to select a Language.
5. Press the **SET** button to confirm the setting and to close the menu window.



## Selecting Menus and Settings

Use the menus as shown below to activate the various shooting and reviewing settings.

1. Set the camera to Shooting Mode, Review Mode, or Video Mode.
2. Press the **MENU** button.
3. Press the ◀ or ▶ arrow to switch between the REC/Playback menu and Setup Menu.
4. Press the ▼ or ▲ arrow to select a menu item then press the **SET** button or the ▶ arrow to enter its submenu.
5. Press the ▼ / ▲ or ◀ / ▶ to select the settings you wish to set then press the **SET** button.
6. Press the **MENU** button to close the menu window.





This chart shows the options for each menu settings.

### Menu Items Selectable with the MENU

	Menu Item	Available Setting	Default Setting
 Shooting Mode Menu	<b>Resolution</b>		(2304 x 1728)
	<b>Quality</b>		(Fine)
	<b>Exposure</b>	+2/+1.7/+1.3/+1.0/+0.7/+0.3/0.0/-0.3/-0.7/-1.0/-1.3/-1.7/-2.0	0 (Auto)
	<b>White Balance</b>		(Auto)
	<b>Metering</b>	<b>Auto / Multi / Spot</b>	<b>Auto</b>
	<b>Date Stamp</b>	<b>On / Off</b>	<b>Off</b>
	<b>File Reset</b> NO.	<b>On / Off</b>	<b>Off</b>
	<b>Long Shutter</b>	<b>Off / 1 sec / 2 sec / 4 sec / 8 sec</b>	<b>Off</b>



	Menu Item	Available Setting	Default Setting
Setup Menu	<b>Beep</b>	<b>On / Off</b>	<b>Off</b>
	<b>Power Save</b>	<b>Off / 1 min / 3 min / 5 min</b>	<b>1 min.</b>
	<b>Quick View</b>	<b>On/Off</b>	<b>Off</b>
	<b>Date &amp; Time</b>	<b>Sets the date and time</b>	<b>---</b>
	<b>Language</b>	English / Traditional Chinese / Simplified Chinese / Japanese / Korean / German / Franch / Portugese / Italian / Spanish / Dutch / Russian	<b>English</b>
	<b>Format</b>	<b>No / Yes</b>	<b>---</b>
	<b>USB</b>	<b>Computer/Printer</b>	<b>Computer</b>

	Menu Item	Available Setting	Default Setting
Playback Mode Menu	 <b>Protect</b>	<b>Single / Protect All / Unprotect All</b>	<b>---</b>
	<b>Delete All</b>	<b>Single / All</b>	<b>---</b>
	<b>Slide Show</b>	<b>Off / 5 sec / 10 sec</b>	<b>---</b>
	<b>Print Order</b>	<b>Single / All / Reset</b>	<b>---</b>
	<b>Copy To Card</b>	<b>No / Yes</b>	<b>---</b>
Movie Mode REC	 <b>Exposure</b>	<b>+2/+1.7/+1.3/+1.0/+0.7/+0.3/0.0/ -0.3/-0.7/-1.0/-1.3/-1.7/-2.0</b>	<b>Auto</b>
	<b>White Balance</b>		<b>Auto</b>
	<b>File Reset</b> <b>NO.</b>	<b>On / Off</b>	<b>Off</b>

**Note: Every time the camera is powered off, the Exposure, White Balance, Metering, Longer Shutter and USB setting will restore to its default setting.**

# 3 Basic Functions

## Setting the LCD Display Mode

Press the **DISP** button to turn the LCD on or off.

The LCD display changes as indicated below:

### Shooting Mode

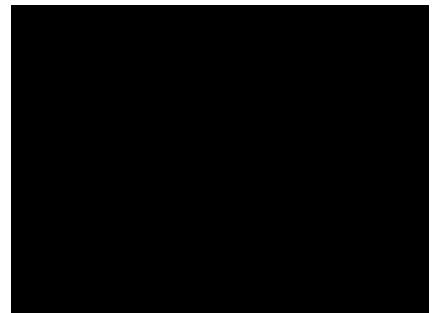
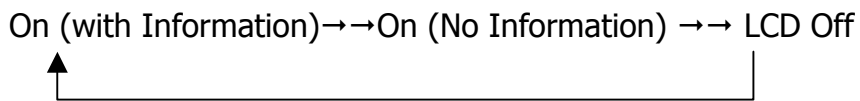

### Playback Mode

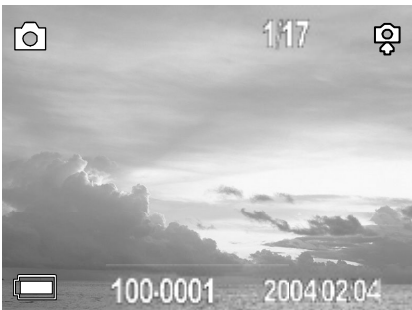
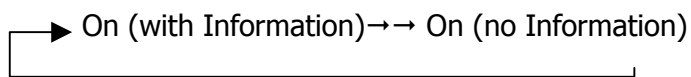

# Information Displayed on the LCD Monitor

The LCD displays information such as the camera settings, remaining image capacity and shooting date etc.

## Shooting Mode

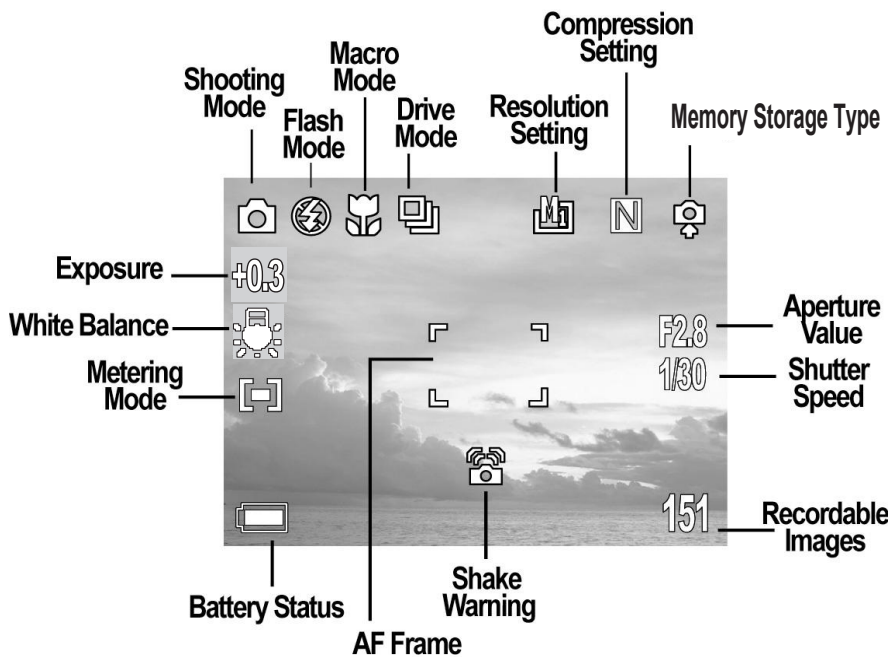

## Playback Mode

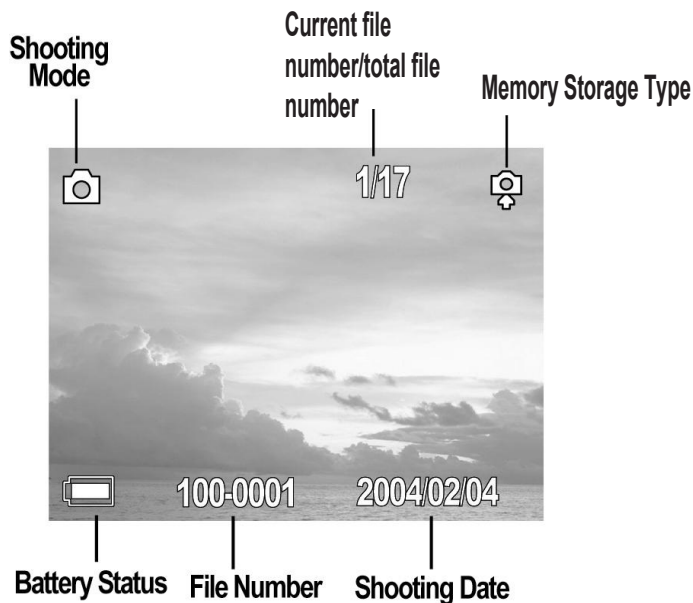

## Using the Zoom Feature

The camera has a 3x optical zoom lens with an effective zoom range 5.8 mm to 17.4 mm (equivalent to 37 mm to 111 mm in 35 mm film format) as well as 4x digital zoom capability.

1. Press **T** (Tele) to zoom in to your subject.
  - While the optical zoom is activated, mechanical sound come from the lens movements can be heard. You can also see the lens retracts.
  - While the digital zoom is activated, the zoom scale indicator will be shown on the LCD.

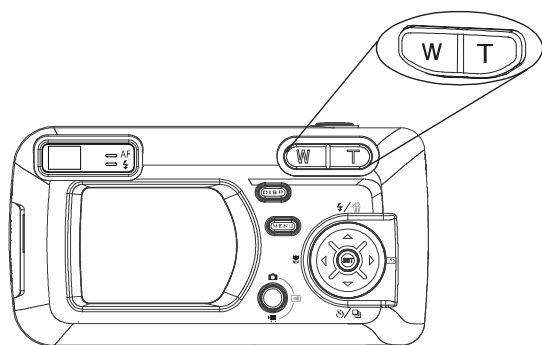

the current approximate zoom factor

2. Press **W** (Wide) to zoom out.

# 4 Taking Pictures

## Basic Still Image Shooting

In this mode, all you have to do is press the shutter button and let the camera do everything else.

1. Set the Camera Mode button to .

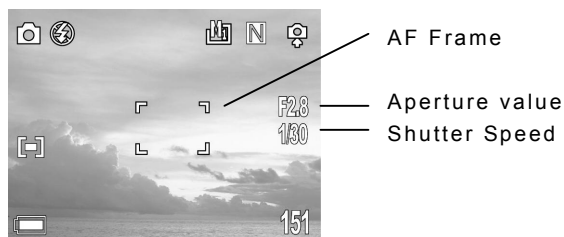

2. Aim the camera at the subject.

3. Press the T or W button to zoom in or out.

Mode	Focus Range
W mode	10 cm (3.94 inch) to infinity ( $\infty$ )
T mode	50 cm (19.89 inch) to infinity ( $\infty$ )

4. Press the **Shutter** button halfway down to activate the auto-focus until AF LED stops blinking and the white AF Frame turned into green.

- The shutter speed and aperture values appear on the LCD monitor.

5. Press the **Shutter** button fully down to capture the image.







1. If the Shaking Warning indicator () is shown on the LCD, that means the shutter speed is low, and you should place the camera on a tripod or a steady place before shooting in order to ensure the image quality.

2. In the following conditions, the AF LED will continue to blink and the AF Frame will remain in red:

- There are several subjects at different distances within the focus lock area. Recompose the picture by moving the camera slightly.
- There is no color contrast. Recompose the picture with a subject that contains more color.
- There is insufficient lighting. If possible, increase the lighting in the surrounding area.

## Reviewing the Image after Shooting







The quick playback function is available in both Shooting Mode and Video Mode.

- Press  to view the just captured photo or video clip.
  - To delete the file, press . Then press  and  to select YES or NO, and then press **SET** to confirm.
- Press  again to return to shooting mode.



## Setting the Image Quality and Resolution

You can change the image quality and resolution to suit your purpose.

- Press the **MENU** button.
- Press the  or  arrow to select the REC Menu.
- Press the  or  arrow to select **Resolution** or **Quality** then press the **SET** button or  arrow to enter its submenu.
- Press the  or  to select the settings you wish to set then press the **SET** button.
- Press the **MENU** button twice to close the menu window.









	Resolution	Purpose
 (Large 1)	2592×1944	Print large prints
 (Large 2)	2304×1728	Print large prints
 (Medium 1)	1600×1200	Print on small size paper
 (Medium 2)	1024×768	Send images by e-mail
 (Small)	640×480	Shoot more images

Image Quality		Purpose
F	Fine (5x compression rate)	Shoot high quality images
N	Normal (8x compression rate)	Shoot normal quality images
E	Economy(12x compression rate)	Shoot more images.

## Using the Flash

Use the flash according to the guidelines below.

⚡A	Auto	The camera judges if a flash is required. If the environment is too dark, the flash will fire.
⚡	Force On	The flash always fires.
⚡⊘	Force Off	The flash does not fire.
⊘	Red-eye reduction, Auto	The camera will automatically detect when the flash is needed and the flash will fire after a short delay to prevent Red-Eye phenomenon.

- Press the  button to switch between flash modes.
  - The selected flash mode icon appears on the LCD monitor.
- Shoot the image.

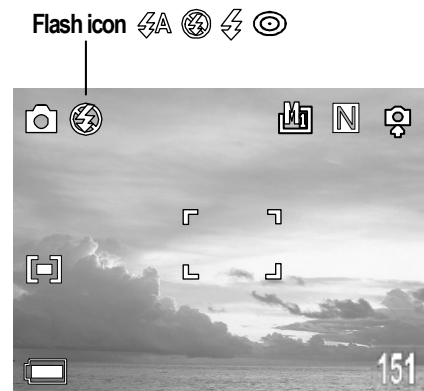

### Tips on Red-Eye Reduction feature:

Shooting with flash in dark places, the subject's eyes may appear red in the picture. This phenomenon is known as "Red-Eye" and occurs when flash reflects back from the retina. With the Red-Eye Reduction feature, the camera can contract the pupils of the subject by lighting for about 1 second before the flash is fired to reduce the chances of Red-Eye.

## Setting the Metering Mode

The camera enables you to select the metering mode to suit the shooting conditions and purpose.

### Multi-pattern metering

The image is divided into multiple regions and metering is performed for each region. The camera judges the subject position and background brightness, and determines a well-balanced exposure.

### Center-weighted metering



Averages the exposure from the entire image, but places more weight on the subject at the center. Use this mode when the subject is backlit or surrounded by bright light.

1. Press the **MENU** button.
2. Press the **◀** or **▶** arrow to select the REC Menu.
3. Press the **▼** or **▲** arrow to select **Metering** then press the **SET** button or **▶** arrow to enter its submenu.
4. Press the **▼** or **▲** to select the settings you wish to set then press the **SET** button.
5. Press the **MENU** button twice to close the menu window.



## Macro Mode

Use the macro mode to shoot close-up of subjects in the range of 10 cm to 50 cm (3.94 in. to 19.89 in.).

1. Press the DISPLAY button to turn the LCD monitor on.
2. Press the **◀**  button.
  - The **◀**  icon appears on the LCD monitor.
3. Shoot the image.







1. Focus range mentioned is the distance between the camera lens surface and the subject.
2. Any flash setting can be used in macro mode.
3. Always use the LCD monitor to compose images in macro mode. Shooting with the optical viewfinder is possible, however, images composed with the optical viewfinder might be off-center due to the parallax phenomenon.

## Setting the Self-Timer and Continuous Shooting

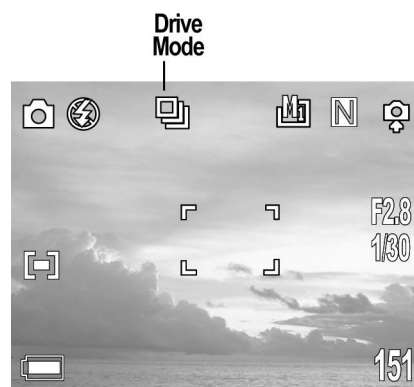
1. Press the  button to switch between Drive modes until the selected drive mode icon appears on the LCD monitor.
2. Shoot the image.





Setting	Description
	Ten seconds
	3 images at 1600 x 1200 resolution

### Shooting with Self-Timer

- If you selected Self-Timer () , after the Shutter button is fully pressed down, the red Self-Timer LED in the front of the camera will blink slowly for 7 seconds, faster for the remaining 3 seconds, then the image will be captured.
- The Self-Timer is automatically deactivated once the image is taken.

### Continuous Shooting

- The camera will automatically and continuously capture 3 consecutive images at approximately 1 images per second in 1600 x 1200 resolution.
- To exit the Continuous Shooting function, press the  button until  disappears from the LCD.

## Shooting in Long Shutter Mode

You can set the shutter speed to a slow setting to make dark subjects appear brighter.

Available Shutter Speeds are: 1 sec, 2 sec, 4 sec and 8 sec.

1. Press the **MENU** button.
2. Press the ◀ or ▶ arrow to select the REC Menu.
3. Press the ▼ or ▲ arrow to select **Long Shutter** then press the **SET** button or ▶ arrow to enter its submenu.
4. Press the ▼ or ▲ to select the settings you wish to set then press the **SET** button.
5. Press the **MENU** button twice to close the menu window.

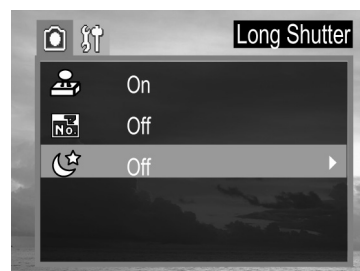

When slow shutter speed is selected, place the camera on a flat surface or on a tripod before shooting to avoid shaking.

## Adjusting the Exposure ---EV adjustment





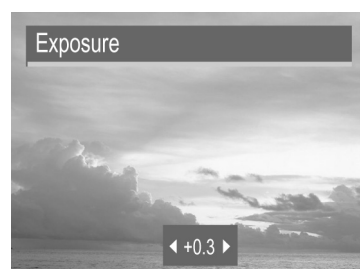

The camera uses Auto Exposure to give well-exposed pictures under most lighting conditions. If the captured picture of the main subject turns out to be too light or too dark, use the Exposure Compensation feature to improve the exposure aspect.

1. Press the **MENU** button.
2. In the camera menu, press the ▼ or ▲ arrow to select **Exposure** then press the **SET** button.
3. Press the ◀ and ▶ to set the exposure compensation value. Available settings are: -2.0, -1.7, -1.3, -1.0, -0.7, -0.3, 0.0, +0.3, +0.7, +1.0, +1.3, +1.7, +2.0 then press the **SET** button.



## Adjusting Color Tones ---Setting the White Balance

By default the camera uses Auto White Balance to reproduce colors under different lighting conditions. For mixed lighting conditions, it is recommended to use the Auto White Balance option. However, if the lighting condition is identical to one of the following White Balance settings, set the White Balance to the corresponding mode to get pictures with colors more accurately.

	Auto	The camera will automatically choose the white balance setting.
	Day light	For recording outdoors on a bright day
	Shade	For recording under overcast, shady or twilight skies
	Tungsten	For recording under tungsten lighting
	Fluorescent	For recording under fluorescent lighting
	Black & white	For recording black & white photo

1. Press the **MENU** button.
2. In the camera menu, press the **▼** or **▲** arrow to select **white balance** then press the **SET** button.
3. Press the **◀** and **▶** to set the white balance value then press the **SET** button.



## Using the Self-Portrait Mirror

Use the self-portrait mirror to help taking picture with Self-Timer.

1. Press the  button until the Self-Timer icon is shown on the LCD
2. Look at the self-portrait mirror on the front of the camera to confirm the framing.
3. Press the Shutter button to take the picture.

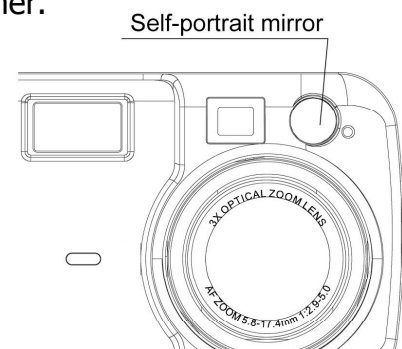

## Video Mode

The digital camera can shoot movie clips with audio (sound only playback on computer).

1. Press the **Camera Mode** button to movie mode .

- The LCD monitor displays the maximum recording time (in minute).

2. Press the Shutter button to start record.

3. Press the shutter button again to stop recording the movie.

- The camera stops recording automatically when the memory capacity is reached.

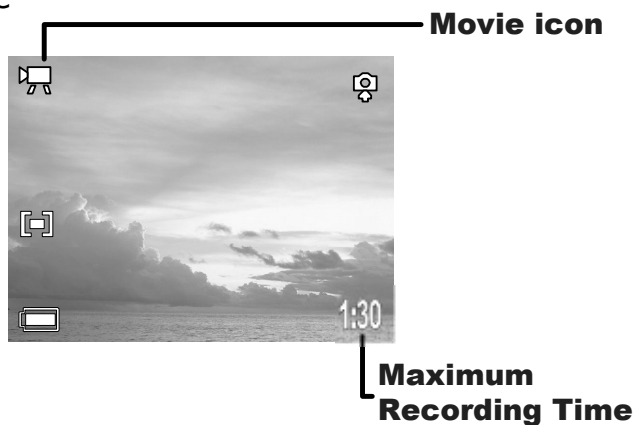

1. The Video resolution is set to  $320 \times 240$  pixels and cannot be changed.
2. The Self-Timer and Macro mode shooting can be activated in Video Mode. (p. 22-23)
3. The Exposure compensation and White Balance can be adjusted before recording video clip.

# 5 Reviewing Photo & Video Clips

## Reviewing Files

You can view the recorded images and video clips on the LCD monitor.

1. Press **Camera Mode** button to enter the Playback Mode (◀▶). The last recorded image or video clip appears on the LCD monitor.
  - If it is a video clip, only the first frame of the video clip will be shown. Press **SET** button to start playing the video clip.
2. Use ◀ to move to the previous file and ▶ to move to the next file.
3. Press the **Camera Mode** button twice to return to shooting mode.

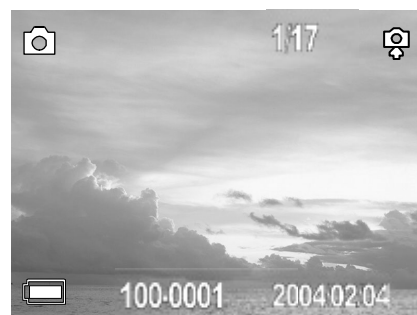
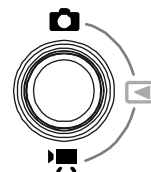

You may turn the picture information such as file no. and date etc. off by pressing the **DISP** button.

## Magnifying Images

Still images can be magnified up from 1 times to 8 times.

1. When the desired image is shown on the LCD, press **T** to magnify the image.
2. Press the ◀, ▶, ▼ or ▲ arrows to move the magnified area around the image.
3. Press **W** to zoom out.



The zoom factor is shown

## Viewing the Files in Thumbnail Mode

The Thumbnail mode allows you to view up to nine images at a time on the LCD monitor.

1. Press **Camera Mode** button to enter the Playback Mode (◀▶).
2. Press the **W** button to view thumbnail images.
  - The last image is highlighted in red border.
3. Press the ◀, ▶, ▼ or ▲ to select an image.
4. Press the **T** button or the **SET** button to display the selected image in full screen size.

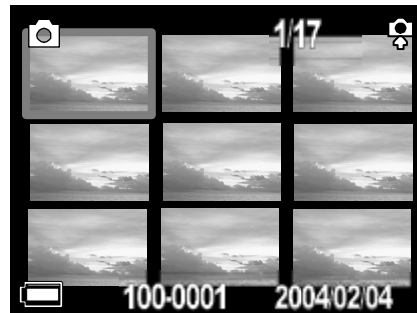

## Erasing Files From Memory

Erase files that you don't want to keep to make more memory space available. You can erase individual files or all files in Playback Mode.

### Erasing Images Individually

1. Press **Camera Mode** button to enter the Playback Mode (◀▶).
2. Use ◀ or ▶ to search for the file you want to delete.
3. Press .
4. Press ▼ or ▲ to select YES or NO.
5. Press **SET** to confirm.



**Note:** Do not press SET repeatedly. Otherwise you may delete other files.

6. Press **MENU** to exit



Please note that erased images cannot be recovered.  
Exercise caution before erasing a file.

## Erasing files by using the Review Menu

1. Press **Camera Mode** button to enter the Playback Mode (◀▶).
2. Press the (MENU) button.
3. Press the ▼ arrow to highlight **Delete ALL** and then press the SET button or the ▶ arrow to enter its submenu.
4. Press ▼ or ▲ to select Single or All, then press the SET button or the ▶ arrow to enter its submenu.
5. Press ▼ or ▲ to select Yes or No, then press the SET button to confirm.
6. Press **Camera Mode** button to exit the Playback Mode.



## Protecting Photos and Video Clips

You can protect important images from being accidentally erased.

1. Press **Camera Mode** button to enter the Playback Mode (◀▶).
2. Press the (MENU) button.
3. Press the ▼ arrow to select **Protect** then press the SET button or the ▶ arrow to enter its submenu.
4. Press ▼ and ▲ to select Single or Protect All, then press ▶ or the SET button to enter its submenu.
5. Press ▼ and ▲ to select Yes or No and then press the SET button to confirm the choice.



**Note:** After pressing the SET button to protect one image, the protect icon will be shown on the right top corner of the LCD. Press the (MENU) button to close the menu window. If you pressed the SET button again before exiting, the file will be unprotected.

To unprotect all the files, follow steps above but select "Unprotect All " when protect Menu is shown on the LCD.

## Playing a Slide Show (Auto Play)

Use the slide show feature to automatically display your pictures and videos on the LCD screen at a selectable interval.

1. Press **Camera Mode** button to enter the Playback Mode (◀▶).
2. Press (MENU) button.
3. Press the ▼ arrow to select **SLIDE SHOW** then press the **SET** button or the ▶ arrow to enter its submenu.
4. Press the ▼ or ▲ to select 5 sec or 10 sec and then press **SET**. The slide show starts at once from the last displayed image. For Video clips, only the first frame will be shown.
5. Press the **SET** button to stop the slide show.



## Copying Files from Internal Memory to an SD Card

The camera allows you to copy all files that are stored in the camera's internal memory to an SD memory card.

1. Insert an SD card and press the Camera Mode button to enter the Playback Mode (◀▶).
2. Press the (MENU) button.
3. Press the ▼ arrow to select **Copy to card** then press the **SET** button or the ▶ arrow to enter its submenu.
4. Press ◀ and ▶ to select YES or NO, then press **SET** to confirm.



## Setting USB Mode

You can set USB mode to connect the camera with a printer or computer.

1. Press the **Camera Mode** button to enter the Playback Mode (◀▶).
2. Press the (MENU) button.
3. Press the ▶ arrow to select the Setup Menu.
4. Press the ▼ or ▲ arrow to select **USB** then press the **SET** button.
5. Press the ▼ or ▲ to select Computer or Printer and then press the **SET** button.





# 6 File Names & Printing

## About File and Folder Numbers

Images or video clips are assigned file numbers from 0001 to 9999, and folders are assigned folder numbers from 100 to 999

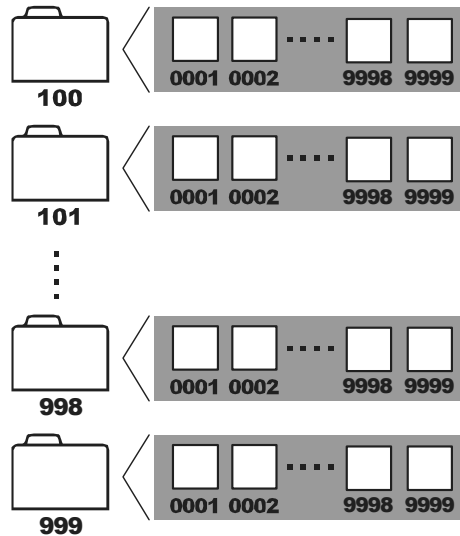

## Folder File Capacity

Each folder usually contains up to 999 images. If a photo is taken when the file number has reached 0999, the camera will create a new folder. For example, if the current folder is "100DICAM", the new folder will be named "101DICAM."

If the total folder number reached 999 and the total file number exceeds 9999, the camera will display the warning message "FILE NUMBER OVER." In this case, please set the File Number Reset to ON mode and then format the memory or insert a new memory card. (p.32)

## File Number Reset

Setting the File No. Reset to OFF is useful for avoiding file name duplication when files are downloaded to a computer. However, if you want to start numbering files from 0001 after a new SD card is inserted, or after the memory is formatted, or when you experience a “FILE NUMBER OVER” warning (p. 31), set the File Number Reset mode to ON.

Mode	Off (Default)	On
Situations		
1. A new SD card is inserted. 2. The internal memory or the memory card is formatted	File number will start from the previous number. For example: <b>0065 → 0066</b>	File numbers will reset to 0001. For example: <b>0065 → 0001</b>

### ***To numbering the files from 0001 when a new SD card is inserted:***

1. Insert a new SD card.
2. Turn the camera on and press the **MENU** button.
3. Press the ◀ or ▶ arrow to select the REC Menu.
4. Press the ▼ or ▲ arrow to select **File NO. Reset** then press the **SET** button or ▶ arrow to enter its submenu.
5. Press the ▼ or ▲ to select On and then press the **SET** button.
6. Press the **MENU** button twice to close the menu window.



### ***To number the files from 0001 when memory is formatted:***

1. Follow steps 2-6 above to set the File No. Reset to ON mode.
2. Format the memory. (Refer to p. 9)

## DPOF Print Settings

The Digital Print Order Format (DPOF) setting allows you to select images for printing and specify the number of print copies in advance using the camera. This is extremely convenient for sending the images to a photo developing service or for printing on a direct print compatible printer.

1. Press **Camera Mode** button to enter the Playback Mode (◀▶).
2. Press the ◀ or ▶ arrow to select the images to be printed.  
**Note:** Video Clips can't be printed. Do not select Video file.
3. Press (MENU) button.
4. Press the ▼ or ▲ arrow to select **Print Order**, and then press **SET** or ▶ to enter its submenu.
5. Press the ▼ or ▲ arrow to select **Single, All, Reset**, then press the **SET** button or ▶ to enter its submenu. Then follow one of the below methods:



### **To set different printing order for single images**

1. Press the ▼ or ▲ to set the number of copies (up to 999), then press ▶ to confirm the setting.
2. Press the ▼ or ▲ to set date on/off, then press ▶ to confirm the setting.
3. Press the SET button to confirm.
4. Press the ◀ or ▶ arrow to select the other images to be set for printing.
5. Repeat step 1-3 to set the printing format.
6. When all is set, press the (MENU) button to close the menu window.

### **To set same Print Order for all images**

1. Press the ▼ or ▲ to set the number of copies (up to 999), then press ▶ to confirm the setting.
2. Press the ▼ or ▲ to set date on/off, then press ▶ to confirm the setting.
3. Press the SET button to confirm.

## Printing still images with a PictBridge printer

You can directly print the images captured with your camera by using a PictBridge-compliant printer.

1. Set the USB mode to **Printer**. (P.29)
2. Connect camera with the printer with the supplied USB cable.
3. Turn on the camera and the printer.

### Printing images

The PictBridge menu will be shown on the camera's LCD automatically when the camera is properly connected to a printer that supports PictBridge.

1. Press the  $\blacktriangledown$  or  $\blacktriangle$  arrow to highlight **Image**, then press **SET** to enter its submenu.
2. Press the  $\blacktriangledown$  or  $\blacktriangle$  arrow to select **Single** or **All** then press the  $\blacktriangleright$  button.
3. Press the  $\blacktriangledown$  or  $\blacktriangle$  to set the number of copies (up to 30), then press **SET** to confirm the setting.
4. Press the  $\blacktriangledown$  or  $\blacktriangle$  arrow to select **Print** then press the  $\blacktriangleright$  button.
5. Press the  $\blacktriangledown$  or  $\blacktriangle$  arrow to select **Custom** then press the  $\blacktriangleright$  button.

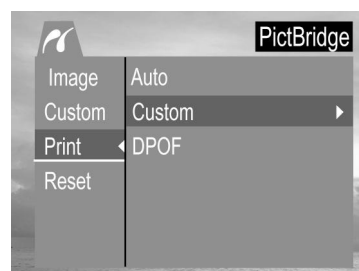
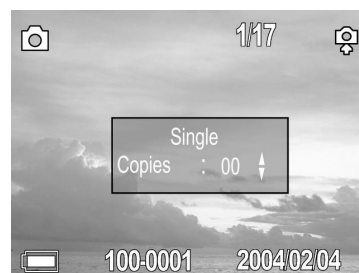
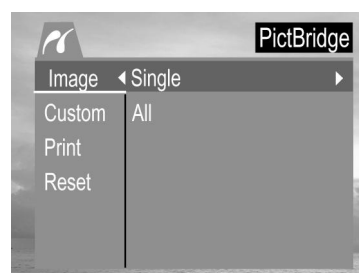

6. Press the ▼ or ▲ arrow to select **Start** then press the **SET** button. The images will be printed.





## Setting Print Size

1. In **PictBridge** menu, press the ▼ or ▲ arrow to select **Custom**.
2. Press ▶ to enter the setting menu.
3. Press the ▼ or ▲ arrow to select **Size** then press the ▶ button.
4. Press the ▼ or ▲ to set the size of print, then press **SET** to confirm the setting.

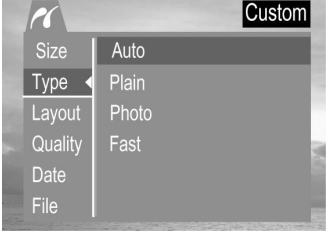

## PictBridge Custom Menu

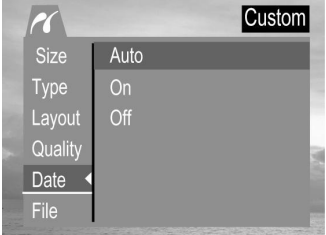
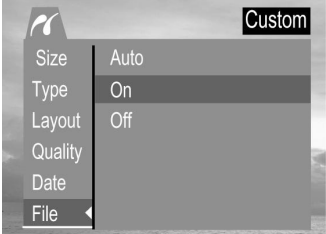
Item	Menu Screen	Settings Content
<b>Size</b>		Auto Postcard 4 × 6 8 × 10 A6 A4 B5
<b>Type</b>		Auto Plain Photo Fast
<b>Layout</b>		Auto 1 2 4 6 8 Index Full
<b>Quality</b>		Auto Draft Normal Fine
<b>Date</b>		Auto On Off
<b>File</b>		Auto On Off

# 7 SOFTWARE INSTALLATION GUIDE

The software that comes with your Concord 4340z includes driver, reader, and photo editing programs. These programs transfer the pictures or video clips from your camera to your computer, and enable you to view them on your computer monitor. Refer to the following list of computer system requirements for installation of the programs.

## Computer System Requirements

### Windows

- 300MHz Pentium II processor or equivalent.
- Microsoft Windows 98/98SE, Windows Me, Windows 2000 Professional, Windows XP Home / Professional / Media Center
- 360MB free hard disk space .
- 128MB of RAM
- Minimum 800 x 600 display with 16-bit color (1024 x 768 with 24-bit color or better is recommended)
- USB Port
- 4x CD-ROM Drive

### Macintosh

- Mac OS 9.0, 9.1, 9.2 and X 10.1 or later
- Power PC-based
- 32MB of RAM
- 640 x 480 display with Thousands of colors (Millions of colors recommended)
- Built-In USB Port

## USING THE INSTALLER SPLASH SCREEN

The installer will automatically detect which software applications need to be installed or if they are not necessary. This will be indicated by the buttons on the splash screen that appears when the CD-ROM is inserted into the computer:

Color	Description
Yellow ( ● )	Required or highly recommended to install.
Gray ( ● )	Already installed or not necessary to install.

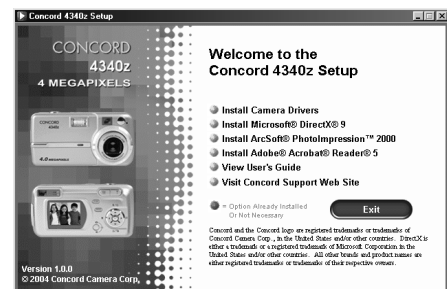

Option	Description
Camera Drivers	The USB Mass Storage camera drivers enable the camera to become an external drive on your computer.
Microsoft DirectX 9	DirectX 9 enables the movie playback applications on your computer to playback video clips that are captured with the camera.
ArcSoft PhotoImpression 2000	This photo software enables you to edit and enhance pictures.
Adobe Acrobat Reader 5	Adobe Acrobat Reader enables you to view the electronic version of the User's Guide.
User's Guide	Direct link to our camera support website. Ensure that an internet connection is established before clicking on the link.

## IDENTIFYING YOUR OPERATING SYSTEM

### Windows

1. Right click the My Computer icon on your desktop, and go to Properties.
2. The System Properties Box will appear.(fig.1.1)  
The information about your computer is listed under the system area.
3. Confirm that your computer is running one of the following operating systems and proceed to the page in the chart for installation instructions:

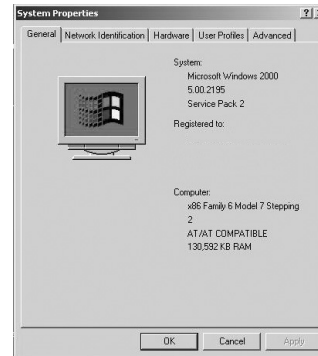

System	Proceed to page
Windows 98, Windows 98 Second Edition	Page 38
Windows 2000	Page 40
Windows Millennium Edition, Windows XP Home Edition, Windows XP Professional Edition, Windows XP Media Center Edition	Page 41

4. Press **OK** to close the window

For Windows 98/98SE/Me/2000, if the **My Computer** icon is not on your desktop, click **Start > Settings > Control Panel** to display the Control Panel window (fig. 1.2). Double click on System icon to open the System Properties Box (fig. 1.2).

For Windows XP, if the My Computer icon is not on your desktop, click Start > Control Panel > Performance and Maintenance, then click on the System icon to open the System Properties Box (fig.1.1).



## Macintosh

1. In the Apple Menu on the Menu bar, select About this Computer.
2. A window will appear with the computer's operating system version. Confirm that your computer is version 9 or higher.

No installation of software is necessary for Macintosh users, please go to Page 47 for connecting your camera to the computer.

## INSTALLING THE DRIVER AND DIRECTX 9 – WINDOWS 98/98SE

**Do not connect** the camera to your computer **BEFORE** the camera drivers and Microsoft DirectX 9 installation is completed.

**Step 1** Make sure your camera is powered off and not connected to the computer.

**Step 2** Make sure the computer is powered on and Windows 98 or 98SE is running.

**Step 3** Close any other applications or software you may be running.

**Step 4** Insert the supplied CD-ROM into your computer's CD-ROM Drive.

**NOTE:** If the installer does not start automatically within 30 seconds after the CD-ROM has been inserted, click on "**My Computer**" either on the Desktop or in the Start Menu and locate the CD-ROM Drive. Double click on the CD-ROM Drive icon for installation and proceed to Step 5.

**Step 5** Select the language. Click [**OK**]. (fig. 1.1)

**Step 6** The installation screen will appear. Click on **Install Camera Drivers**. (fig. 1.2)

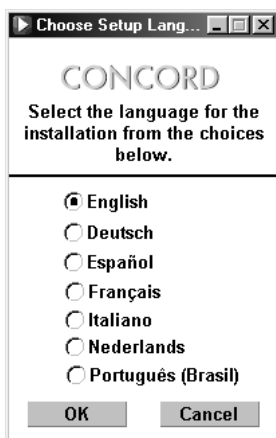

fig. 1.1



fig. 1.2

**Step 7** Click [**Next >**]. (fig. 1.3)

**Step 8** The next dialog will prompt you to select the components that will be installed. **USB Mass Storage Driver** and **DirectX 9** will be pre-selected. The files will be saved in the Concord Camera directory automatically. OR You may change the default folder by clicking [Browse...] and selecting a different folder in your computer. Click [**Next >**]. (fig. 1.4)

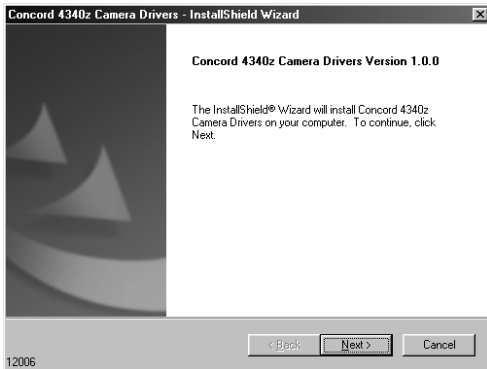

Fig. 1.3

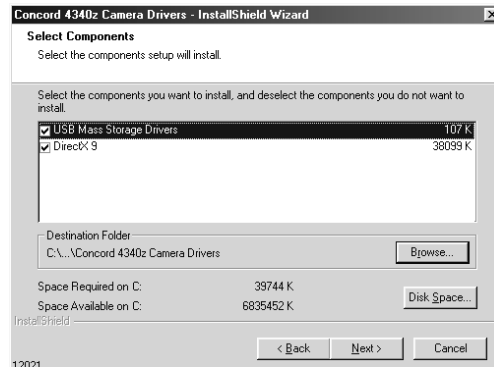

Fig. 1.4

**Step 9** Click [Install]. (fig. 1.5)

**Step 10** Install progress bar.

**Step 11** The next screen will begin the DirectX setup.

Select " I accept the agreement " then click [**Next >**]. (fig. 1.6)

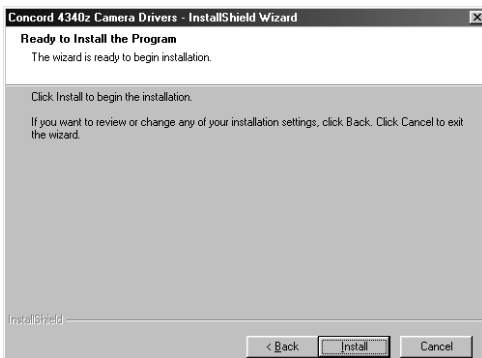

Fig. 1.5

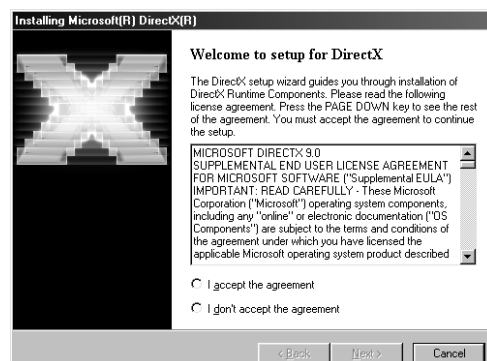

Fig. 1.6

**Step 12** Click [Next >]. (fig. 1.7)

**Step 13** Click [**Finish**]. Your computer will automatically restart. (fig. 1.8)

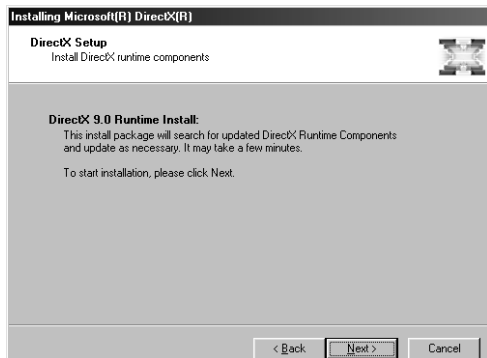

Fig. 1.7

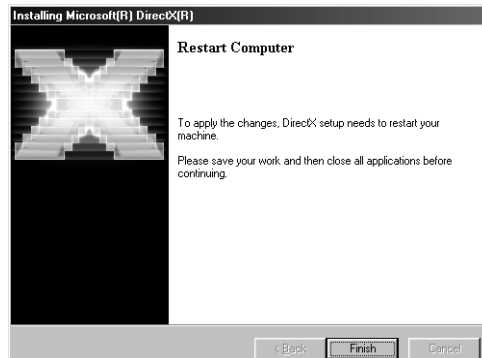

Fig. 1.8

## INSTALLING DIRECTX 9—WINDOWS 2000

**Step 1** Make sure your camera is powered off and not connected to the computer.

**Step 2** Make sure the computer is powered on and Windows 2000 is running.

**Step 3** Close any other applications or software you may be running.

**Step 4** Insert the supplied CD-ROM into your computer's CD-ROM Drive.

**NOTE:** If the installer does not start automatically within 30 seconds after the CD-ROM has been inserted, click on **"My Computer"** either on the Desktop or in the Start Menu and locate the CD-ROM Drive. Double click on the CD-ROM Drive icon for installation and proceed to Step 5.

**Step 5** Select the language. Click **[OK]**. (fig. 2.1)

**Step 6** The installation screen will appear, click on **Install Microsoft DirectX 9.0.** (fig. 2.2)

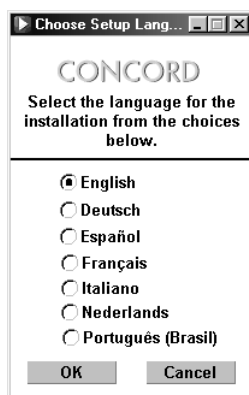

Fig. 2.1

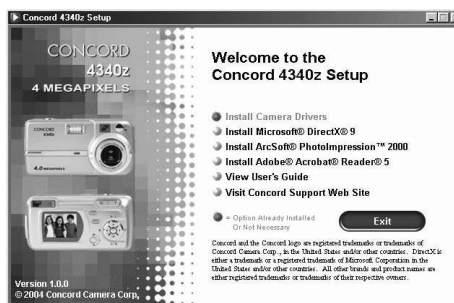

Fig. 2.2

**Step 7** The next screen will begin the DirectX setup.

Select " I accept the agreement " then click **[Next >]**. (fig. 2.3)

**Step 8** Click **[Next >]**. (fig. 2.4)

**Step 9** Click **[Finish]**. Your computer will automatically restart. (fig. 2.5)



Fig. 2.3

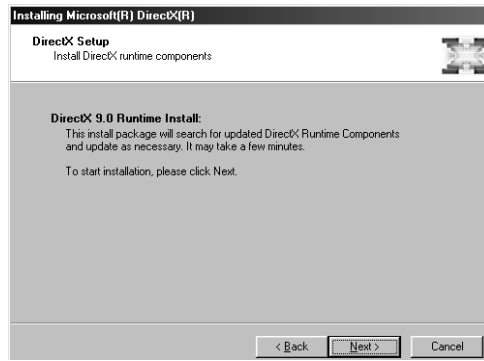

Fig. 2.4

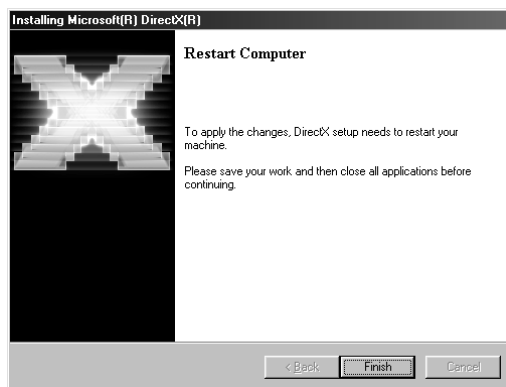

Fig. 2.5

## INSTALLING ARCSOFT PHOTOIMPRESSION – ALL WINDOWS USERS

**Step 1** Make sure your camera is powered off and not connected to the computer.

**Step 2** Make sure the computer is powered on and Windows is running.

**Step 3** Close any other applications or software you may be running.

**Step 4** Insert the supplied CD-ROM into your computer's CD-ROM Drive.

**NOTE:** If the installer does not start automatically within 30 seconds after the CD-ROM has been inserted, click on "My Computer" either on the Desktop or in the Start Menu and locate the CD-ROM Drive. Double click on the CD-ROM Drive icon for installation and proceed to Step 5.

**Step 5** Select the language. Click **[OK]**. (fig. 3.1)

**Step 6** The installation screen will appear, Click on Install ArcSoft PhotoImpression 2000. (fig. 3.2)

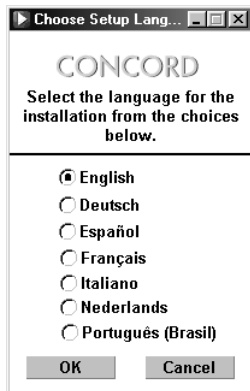

Fig. 3.1



Fig. 3.2

**Step 7** Click [**Next >**]. (fig. 3.3)

**Step 8** Click [**Yes**]. (fig. 3.4)

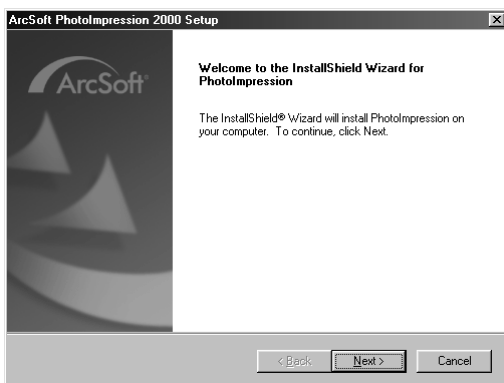

Fig. 3.3

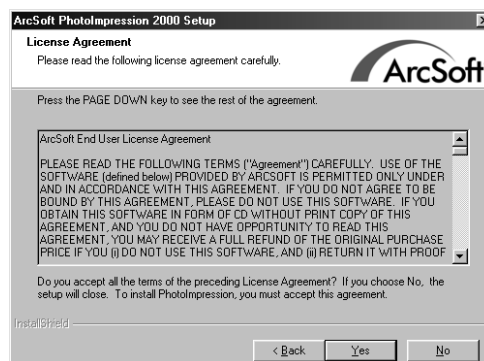

Fig. 3.4

**Step 9** Click [**Next >**]. (fig. 3.5)

**Step 10** Make sure the two applications are checked and then click [**Next >**]. (fig. 3.6)

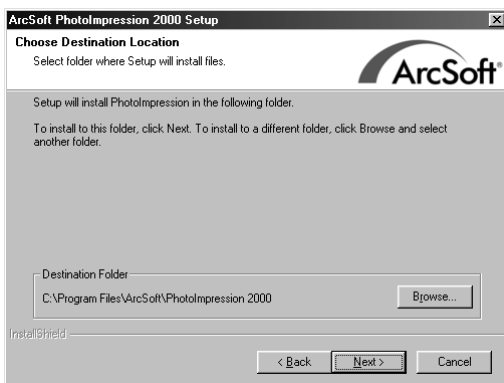

Fig. 3.5

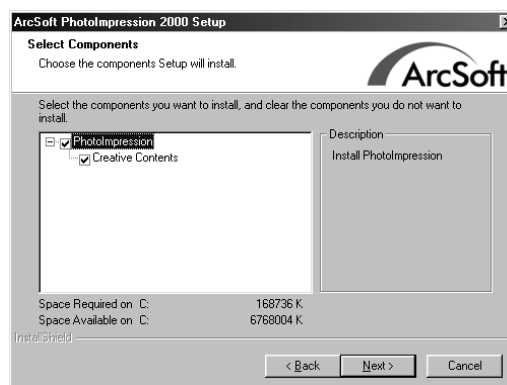

Fig. 3.6

**Step 11** Click [**Next >**]. (fig. 3.7)

**Step 12** The screen will show the status of the installation. (fig. 3.8)

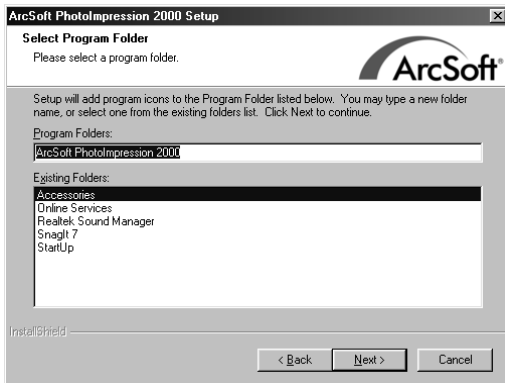

Fig. 3.7

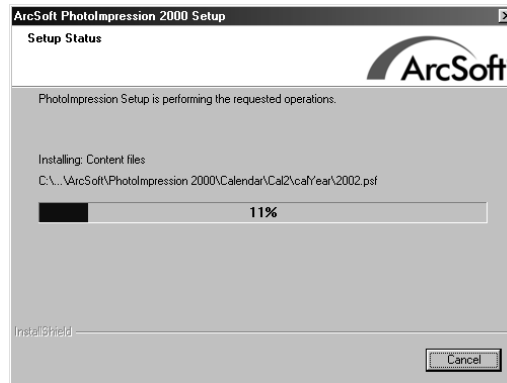
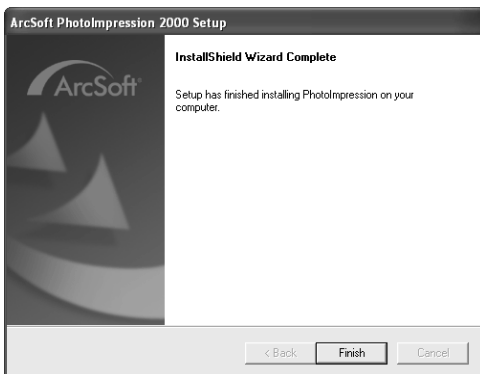
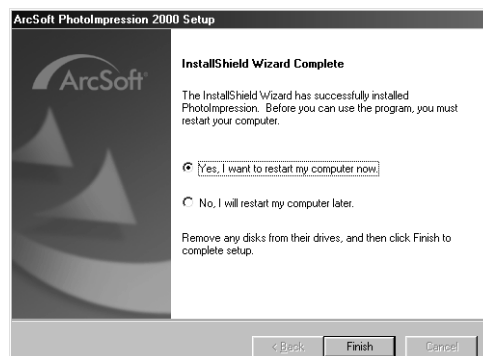

Fig. 3.8

**Step 13** Click [**Finish**]. Win98 will request for restart.



Win 2000 /ME/XP



Win 98 FE/SE

## INSTALLING ADOBE ACROBAT READER 5- ALL WINDOWS USERS (OPTIONAL)

**Step 1** Make sure your camera is powered off and not connected to the computer.

**Step 2** Make sure the computer is powered on and Windows is running.

**Step 3** Close any other applications or software you may be running.

**Step 4** Insert the supplied CD-ROM into your computer's CD-ROM Drive.

**NOTE:** If the installer does not start automatically within 30 seconds after the CD-ROM has been inserted, click on "**My Computer**" either on the Desktop or in

the Start Menu and locate the CD-ROM Drive. Double click on the CD-ROM Drive icon for installation and proceed to Step 5.

**Step 5** Select the language. Click **[OK]**. (Fig. 4.1)

**Step 6** The installation screen will appear, Click on Install Adobe Acrobat Reader 5. (Fig. 4.2)

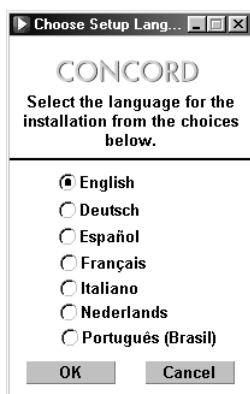

Fig. 4.1



Fig. 4.2

**Step 7** Status bar

**Step 8** Click **[Next >]**. (Fig. 4.3)

**Step 9** The files will be saved into C:\Program Files\Adobe\Acrobat 5 automatically.

**OR**

You may change the default folder by clicking **[Browse...]** and selecting a different folder in your computer.

Click **[Next >]**. (Fig. 4.4)

**Step 10** Installation progress

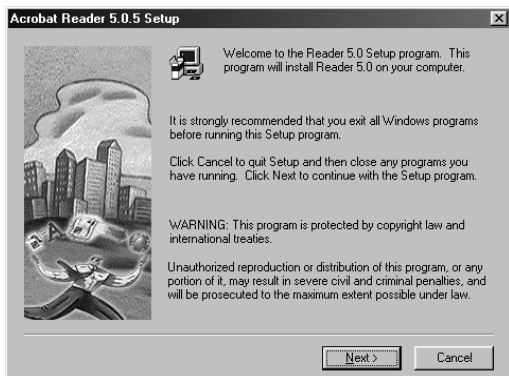

Fig. 4.3

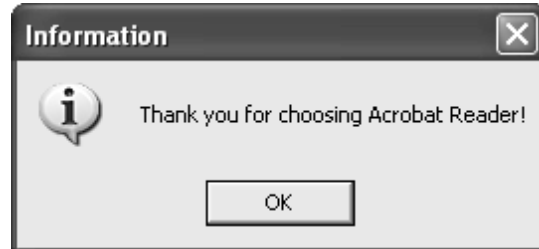

Fig. 4.4

**Step 11** Select Yes, to restart the computer or No, to restart the computer later.  
Click [**Finish >**].



Win 98 FE



Win 98SE/2000/ME/XP



# 8 Making Connections

## Downloading Images to a Computer

Download images taken with the camera to a computer in one of the following ways:

1. Using an SD card reader.
2. Connect the camera to a computer with the USB cable.

**Note for Windows 98 users:** You must install the camera driver supplied in the supplied CD-ROM before connecting the camera to the computer.

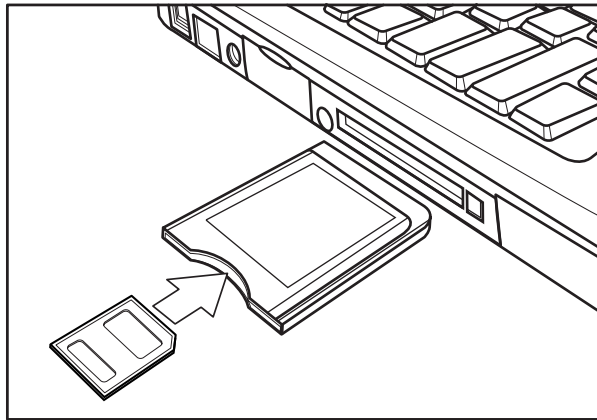

## Downloading the Files by Using an SD Card Reader

1. Take the SD card out from the camera (p.9), and insert it into an SD card reader.
2. Connect the SD card reader to the computer.
3. Double-click the driver icon representing the SD card.
4. Copy the images from the card into a folder on the hard disk of your computer.

## Connecting the Camera to a Computer with a USB Cable



**Note for Windows 98 users:** You must install the camera driver supplied in the CD-ROM before connecting the camera to the computer.

Connect the supplied USB interface cable to the computer's USB port and the camera's DIGITAL terminal.

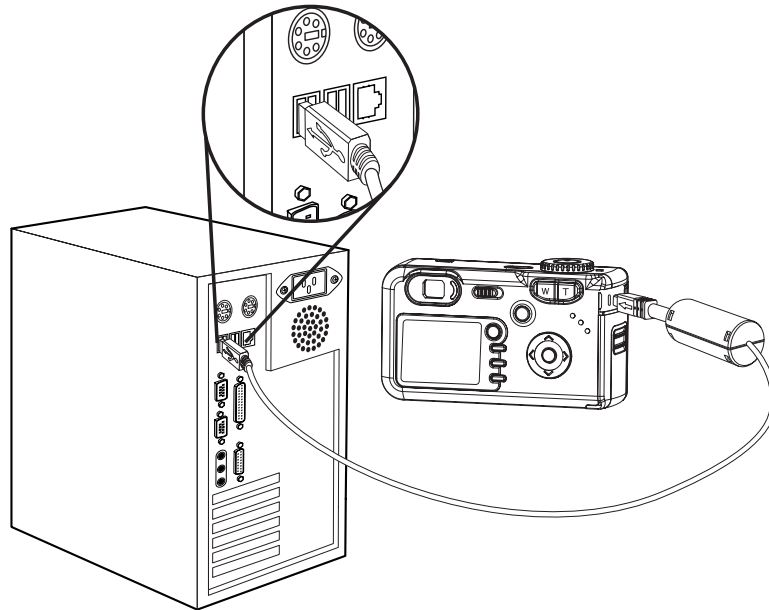

1. You do not need to turn off the computer or camera when making this connection.
2. Please refer to your computer manual for information regarding the location of the USB port.

The LCD monitor turns off when the connection to the computer has been successfully completed.



1. The camera will turn off automatically if the USB cable is disconnected.
2. Use an optional AC power adapter when connected to a computer to save battery power.
3. Windows 98 user: If this is the first time the camera has been connected to the computer, Windows detects the camera as an "Unknown device" and automatically completes the required software installation.

### **FOR WINDOWS USERS**

1. Double-click on My Computer.
2. Double-click Removable Disk.
3. Double-click DCIM.
4. Double-click the folder that contains the desired images to view.
  - . The stored pictures (JPG) and video clips (AVI) stored in the memory card will be displayed

### **FOR MACINTOSH USERS**

1. Double-click the “untitled” removable drive that is on your desktop.
2. Double-click DCIM.
3. Double-click the folder that contains the desired images to view.

## **Understanding Camera Memory and Storage**

### **Internal Memory**

The digital camera is equipped with internal memory. If an SD card is not installed in the camera, all photos recorded by the camera will be stored in the internal memory. If an SD card is installed, photos and video clips are stored on the SD card.

### **Optional SD Memory Card**

Photos, video clips, and other information recorded by the camera are stored on the SD card using the Design Rule for Camera File System (DCF) protocol. The DCF protocol is designed to accommodate file and data exchange between digital cameras and other devices.

### **DCF Protocol**

The DCF protocol defines the format for image file data as well as the directory for the memory card. Photos that are taken by a DCF camera can be viewed on DCF-compatible cameras from other manufacturers.

# USING ARCSOFT PHOTOIMPRESSION (WINDOWS ONLY)

1. Connect the camera to the computer.
2. Launch ArcSoft PhotoImpression software by clicking on Start-Programs-ArcSoft Camera Suite and choosing PhotoImpression from the application list on your screen. (fig. 1.1)



fig. 1.1



fig. 1.2

3. When the Application opens, click on the Camera/Scanner button.(fig. 1.2)
4. Click on the drop-down list under Select Source and choose Concord 4340z.
5. Click on the Camera/ Scanner Icon (  ).
  - A second window will appear showing the contents (pictures) in the memory, and options on how to handle them. (fig. 1.3)



fig. 1.3

6. Select the desired picture to view, edit or save by clicking on it. The selected image will be highlighted by a border. To choose all pictures, click on **Select All**.
7. Click on Get Photos.  
The pictures will then be added to your album at the bottom of the application (fig 1.4).

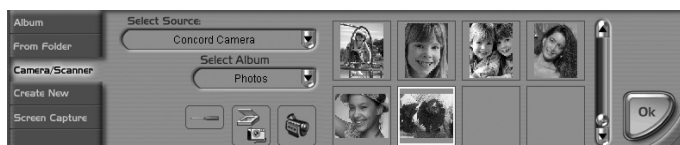



fig. 1.4



fig. 1.5

- 
8. Click on Close to close the Camera Controls windows (as shown in fig. 1.3).
  9. Double-click on the thumbnail or click on OK to open the photo.
  10. Click on Edit to edit the photo. You may, for example,
    - Resize the photo by using the "Crop/Resize" tools.
    - Modify the photo by using the "Retouch" tools. For example, to remove red-eyes.
    - Add some text onto the photo by using the "Text" tools.
  11. Click on Save to save the photo. Two options are available: "Save" and "Save As".
  12. Click on Print to print the photo. The options available include: Standard Printing, Greeting Card/Multiple Printing or Thumbnail Printing.

# 9 Appendix

## Troubleshooting

Problem	Cause	Solution
The camera cannot be turned on.	Batteries are inserted in the wrong direction	Reload the batteries properly (p.8).
	Batteries are dead	Replace or recharge the batteries
	The battery compartment door is open	Make sure the battery compartment door is securely closed.
The camera cannot take pictures	The flash is charging	Wait until the flash is fully charged.
	Memory is full	Insert a new SD card.
	SD card is not formatted correctly	The card may be defective, use a new card.
	Maximum file number is exceeded	Turn "File No. Reset" on, then format the card or insert a new card.
The flash doesn't fire	Flash is set to OFF	Set the flash to any mode except off.
Image is blurry or out of focus	The camera was moving when the image was captured	Hold the camera steady when shooting picture.
	The subject was beyond the range within which the camera can focus	Turn the Macro mode on if the subject is within 10 cm (zoomed out) or 50 cm (zoom in) / don't use Macro mode when shooting distant subjects.
Image is not displayed on the LCD monitor	An SD Card with non-DCIF images (recorded with another camera) is loaded	This camera cannot display non-DCIF images.
Recorded images are not saved in memory	The camera was turned off/powered down before the image was stored in memory	If the Battery Low indicator appears on the LCD monitor, replace the battery immediately.
Cannot transfer images to a computer after connecting the USB cable	USB driver is not installed	Install the USB driver before you connect the camera to a computer / turn the camera on.

## Specifications

<b>Sensor</b>	4.24 Mega Pixels CCD Size : 1/2.5 inch
<b>Lens</b>	Olympus 3× zoom lens
<b>View Finder</b>	Optical with real image
<b>Color LCD Display</b>	1.5" TFT LCD Panel
<b>Focus Range</b>	10 cm (3.94") ~ infinity (W ) 50 cm (19.89") ~ infinity (T),10cm(3.94")~50cm(19.89") (Macro)
<b>ISO/ASA Sensitivity</b>	100
<b>Still Image Resolution</b>	2592 × 1944, 2304 × 1728, 1600 × 1200, 1024 × 768, 640 × 480,
<b>Video Resolution</b>	MJPEG, (320 × 240) up to 20 fps, with audio (sound playback on computer only)
<b>Still Image quality</b>	Fine : 5 × compression rate Normal : 8 × compression rate Economy: 12 x compression rate
<b>Exposure Control</b>	Auto & Manual
<b>Exposure Compensation</b>	-2EV to +2EV in 1/3 step.
<b>Exposure Meter</b>	Center-weighted average, Multi-pattern TTL AE
<b>Shutter</b>	Mechanical shutter, 1/2000 ~ 8 sec. with CCD variable electronic shutter
<b>Optical Zoom</b>	Effective 3x, continuous
<b>Digital Zoom</b>	Shooting mode : 4×, continuous Playback mode : 8 ×, scrollable
<b>Image File Format</b>	Still : EXIF 2.2 compatible format (JPEG compression) DCF compatible. Support DPOF, PIM II, Pictbridge
<b>White Balance</b>	Auto, Day light, Cloudy, tungsten, fluorescent, Black & white
<b>Start-up Time</b>	Less than 3 sec.
<b>Picture Storage</b>	Internal : 16 MB embedded flash memory External : SD memory card up to 512 MB
<b>Microphone</b>	Built-in
<b>Communication Interface</b>	USB 1.1, Compliance with USB2.0
<b>Self-Timer</b>	10 sec. with beep sound
<b>Playback Mode</b>	Single / 9 thumbnails / slide show
<b>Power Supply</b>	Battery : AA Size x 2 DC input : 3.3V 2.0A DC adapter
<b>Dimensions</b>	105 × 55 × 37 (mm) ,4.1x2.2x1.5 (inches)
<b>Weight</b>	Camera body w/o batteries: 150g ,5.25 (oz)
<b>Ambient temperature</b>	Operating : -5 to 40 ° C Storage : -20 to 60 ° C

## GETTING HELP

### Troubleshooting Section in this User's Guide

Please refer to the Troubleshooting section (page 61) first, as it contains some of the most common problems that users encounter. The section lists a number of possible quick-and-easy solutions, which might solve the problem, allowing you to continue enjoying your new Concord 3-Megapixel 3x Optical Zoom Digital Camera

### Website Customer Support/FAQ

For problems that are not listed in the Troubleshooting section, please visit our customer support website at [www.concord-camera.com](http://www.concord-camera.com) to view the Frequently Asked Questions (FAQ) by clicking the appropriate camera model picture in the "Camera Support" Section. Most of the latest support issues are posted and answered in the FAQ section. If the problem you are encountering is not listed either in the troubleshooting section of this User's Guide or the FAQ section on our website, you can also E-mail us by clicking the E-mail address link to the customer support center in the "Camera Support" Section.

### Customer Support

Before You E-mail or Call us

If you have questions concerning the operation of the camera or software installation that are not listed either in the troubleshooting section of this User's Guide or the FAQ section on our website, feel free to speak to or email a customer service representative. Before emailing or calling us, please have the following information ready:

#### Camera Information:

Name of camera model  
Camera Serial Number

#### Computer Information:

Operating System  
Processor Speed (MHz)  
Computer Make and Model  
Amount of memory  
Exact Error message received  
Part Number

#### For Camera Support please contact:

##### Toll Free in the US and Canada:

• (866) 522-6372  
Web: [www.concord-camera.com](http://www.concord-camera.com)

##### Toll in Europe:

• +31-53-4829779

##### Toll Free in Europe:

UK: 0800-1696482  
Spain: 900-973195  
Germany: 0800-1800563  
Italy: 800-781883  
France: 0800-917599



**For ArcSoft Technical Support on Photo Editing Software, please contact:**

**In the USA and Canada**

ArcSoft, Inc.  
46601 Fremont Blvd.  
Fremont, CA 94538  
Tel: (510) 440-9901  
Fax: (510) 440-1270  
E-mail: support@arcsoft.com

**China**

ArcSoft Beijing Co., Ltd.  
No. 6 South Capital Gym Road  
Beijing New Century Hotel Office Building, #1060  
Beijing 100044, China  
Tel: 8610-6849-1368  
Fax: 8610-6849-1367  
E-Mail: tech@arcsoft.com.cn

**Japan**

ArcSoft Japan  
9F, 1-21-9, Higashi-Gotanda,  
Shinagawa-ku,  
Tokyo 141-0022, Japan  
Tel: +81-3-5795-1392  
Fax: +81-3-5795-1397  
E-Mail: support@arcsoft.jp

**Europe**

Unit 14, Shannon Industrial Estate  
Shannon, Co. Clare, Ireland  
Tel: +353 (0) 61-702087  
Fax: +353 (0) 61-702001  
E-Mail: europe@arcsoft.com

**Latin America** (local call only)

Tel (Brazil): 00817-200-0709  
Tel (Chile): 800-202-797  
E-Mail:  
latinsupport@arcsoftsupport.com

**Taiwan**

ArcSoft Inc. Taiwan Branch  
Tel: +886 (0) 2-2506-9355  
Fax: +886 (0) 2-2506-8922  
E-Mail: support@arcsoft.com.tw

Concord and Concord logo are registered trademarks or trademarks of Concord Camera Corp., in the United States and/or other countries. Microsoft and Windows are either registered trademarks or trademarks of Microsoft Corporation in the United States and/or other countries. Mac and Macintosh are registered trademarks or trademarks of Apple Computer, Inc. in the U.S. and other countries. All other brands and product names are either registered trademarks or trademarks of their respective owners.